

승 인	
정식승인	()
한도승인	()

SPECIFICATIONS

CUSTOMER	
ITEM	LINE FILTER
MODEL NAME	
PART No	Φ19 *6mH*V-TYPE
DATE	2009-02-25

검 토	심 사	승 인
승인유효기간	승인일로부터	년

신청회사명	 남선전자주식회사	TEL	02-2689-9418
		FAX	02-2689-8628
주 소	Na-3506, Chungang Circulation Complex, 1258 Kurobon-dong, Kuro-Ku, Seoul, Korea, 152-721		

APPROVAL SHEET

DATE

2008. 08. 13

PAGE

1 / 3

CUSTOMER

PART NAME

LINE FILTER

MODEL NO.

PART NO.

Φ19*6mH*V-TYPE

SIZE NO.

T1911

1. DIMENSION (UNIT:mm)

< TOP VIEW >

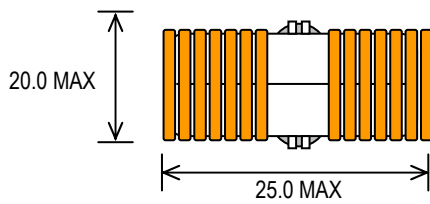

< FRONT VIEW >

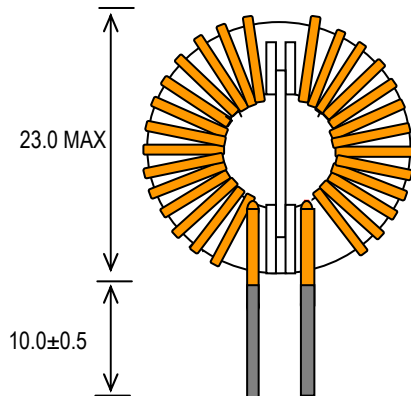

< SIDE VIEW >

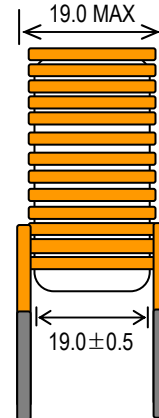

NAMSUN ELECTRONICS CO., LTD.

Na-3506, Chungang Circulation Complex, 1258
Kurobon-dong, Kuro-Ku, Seoul, Korea, 152-721
TEL:02-2689-9418 , FAX:02-2689-8628

DESIGN

CHECK

APPROVAL

개발실
이상순
08.08.13

개발실
김상문
08.08.13

개발실
노성복
08.08.13

FILE NO.

SH - 080813 - 36

APPROVAL SHEET

DATE 2008. 08. 13
PAGE 2 / 3

CUSTOMER			
PART NAME	LINE FILTER	MODEL NO.	
PART NO.	Φ19*6mH*V-TYPE	SIZE NO.	T1911

2. SCHEMATIC DIAGRAM

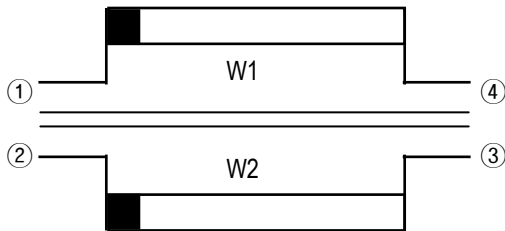

WINDNG	BOTTOM VIEW	C.C.W
N.C PIN		
REMOVE PIN		

3. WINDING SPEC

WINDING ORDER	TERMINAC NO	WIRE	TURNS
W1	1 → 4	UEW 0.8Φ x 1P	31 Ts
W2	2 → 3	UEW 0.8Φ x 1P	31 Ts

4. ELECTRICAL CHARACTERISTIC

NO	CLOSURE	TERMINAL NO.	ELECTRICAL CHARACTERISTICS	TOLERANCE	CONDITION
1	INDUCTANCE	1 → 4 2 → 3	6.0 mH	± 30%	PM - 6306 LCR-METER at 1.0 KHz. LEVEL : 1.0V
2	DC CURRENT OVERLAP	DC 0.5m A, (START TO FINISH)			
3	INSULATION RESISTANCE	DC 500V, 100MΩ MIN(COIL TO CORE)			

NAMSUN ELECTRONICS CO., LTD.

Na-3506, Chungang Circulation Complex, 1258
Kurobon-dong, Kuro-Ku, Seoul, Korea, 152-721
TEL: 02-2689-9418 , FAX: 02-2689-8628

DESIGN	CHECK	APPROVAL
개발실 이상순 08.08.13	개발실 김상문 08.08.13	개발실 노성복 08.08.13
FILE NO.	SH - 080813 - 36	

APPROVAL SHEET

DATE

2008. 08. 13

PAGE

3 / 3

CUSTOMER

PART NAME

LINE FILTER

MODEL NO.

PART NO.

Φ19*6mH*V-TYPE

SIZE NO.

T1911

5. INTERNAL STRUCTURE

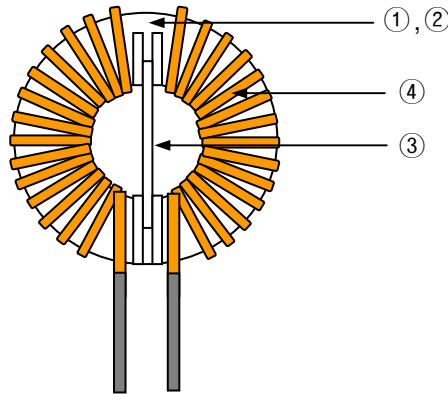

6. MATERIAL LIST

NO	COMPONENT	NAME OF MATERIAL	MANUFACTURER OF MATERIAL	REMARKS
1	CORE	HM5A T1911	ISU CO.,LTD.	
2	CORE COVER	PBT (SK655FR) PBT (GP-1006-F) PBT (VB-5300GF) UL94V-0 CLASS	EI DUPONT DE NEMOURS & CO.,LTD LG CHEMICAL LTD CHEIL INDUSTRIES INC. (한국보빈)	E41938 E67171(M) E115797
3	COIL SEPARATOR	PBT (SK655FR) PBT (GP-2306-F) PBT (VB-5300GF) UL94V-0 CLASS	EI DUPONT DE NEMOURS & CO.,LTD LG CHEMICAL LTD CHEIL INDUSTRIES INC. (한국보빈)	E41938 E67171(M) E115797
4	WIRE	POLYURETHANE UEW 0.8Φ	TAIHAN ELECTRIC WIRE CO., LTD. CNI CABLE CO.,LTD.	E109312(N) E210918
5	FLUX	HDF 102	HANDOK FLUX	
6	SOLDER	SN99.5%,CU0.5%	DONGBU HANNONG CHEMICAL CO.,LTD.	

NC NAMSUN ELECTRONICS CO., LTD.

Na-3506, Chungang Circulation Complex, 1258
Kurobon-dong, Kuro-Ku, Seoul, Korea, 152-721
TEL:02-2689-9418 , FAX:02-2689-8628

DESIGN

개발실
이상순
08.08.13

CHECK

개발실
김상문
08.08.13

APPROVAL

개발실
노성복
08.08.13

FILE NO.

SH - 080813 - 36